

Zubehörkanal Slim

Zubehörkanäle

Code: 3025 881



EINZELHEITEN

Einbaurand

Unterbau

Material

Edelstahl AISI 304

Finish

Spazzolato Foster

Textur

Bürstung in Linie

Basis

90 cm

Außenmaße

846 x 120 mm

Innenmaße

830 x 72 mm

Breite

84,6 cm

Länge

3 einheit - Slim

Einbauöffnung

Siehe Datenblatt (für alle FT/FTS- und Unterbau-Modelle)

Serienmäßige Ausstattung

Befestigungshaken, Abfluss, im Karton verpackt

Abfluss

Abfluss 1 $\frac{1}{4}$ "

Schlüssel für das Zubehör

Die Längen der Kanäle und des Zubehörs werden in „Einheiten“ angegeben, für die Zusammensetzung muss die Summe der "Einheiten" des Zubehörs der Länge in "Einheiten" des Kanals entsprechen.

TECHNISCHE DATEN

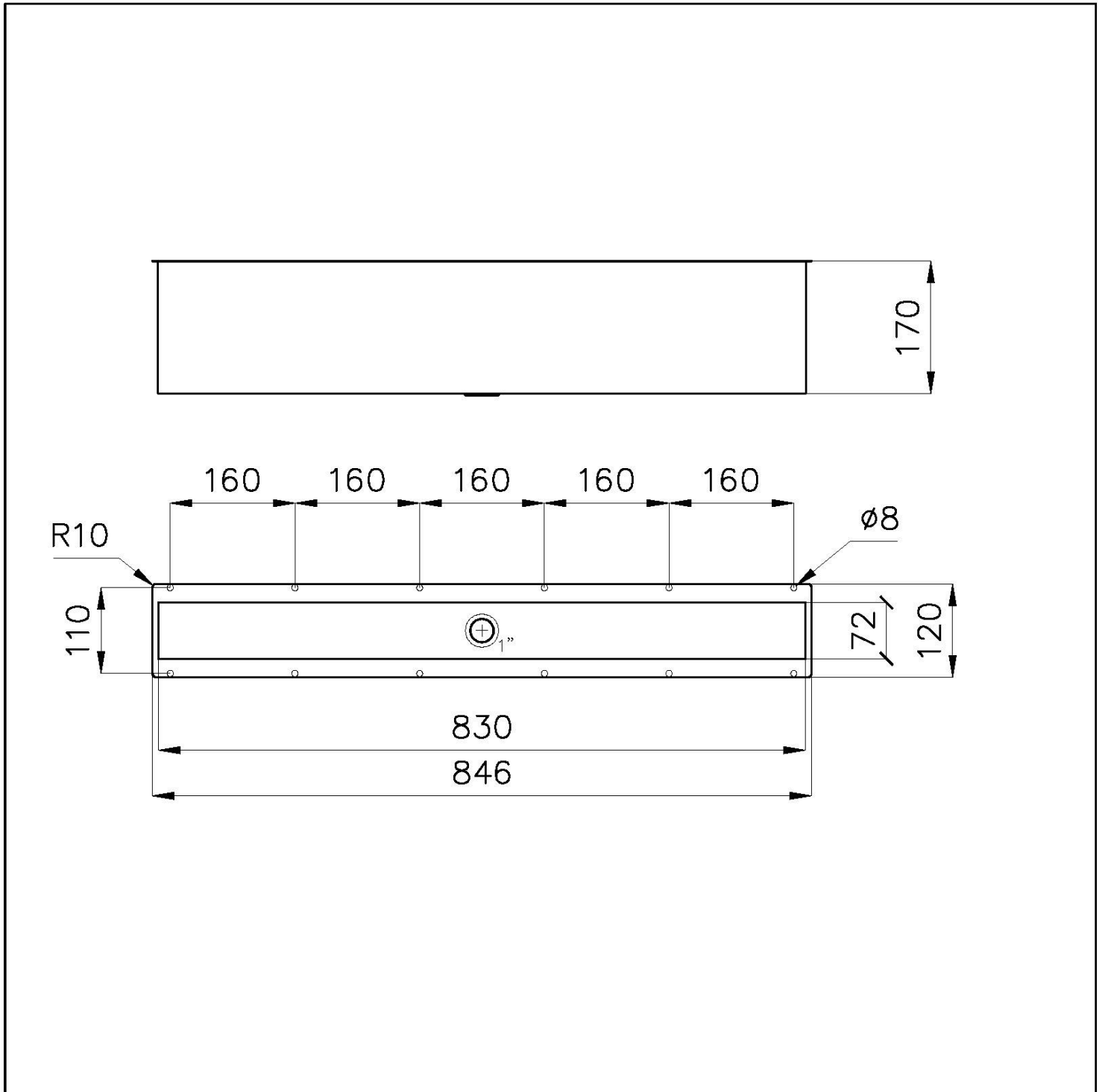

Sottotop/Undermount

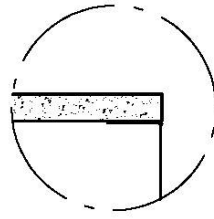

B-B:
 Dettaglio installazione
 Installation detail

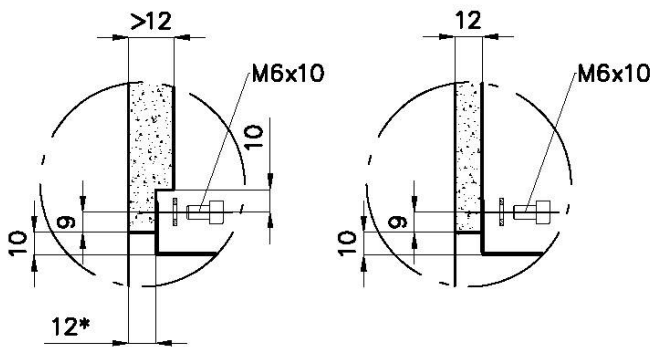

A-A:
 Dettaglio installazione positive reveal e sistema di fissaggio
 Installation detail with positive reveal and fixing system

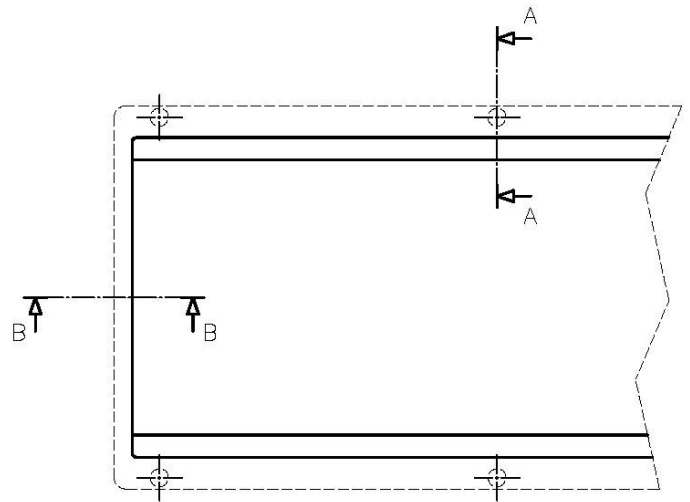

*spessore consigliato per un abbinamento perfetto con gli accessori
 *recommended thickness for a perfect match with the accessories

Dimensioni per foratura top
Cut out size

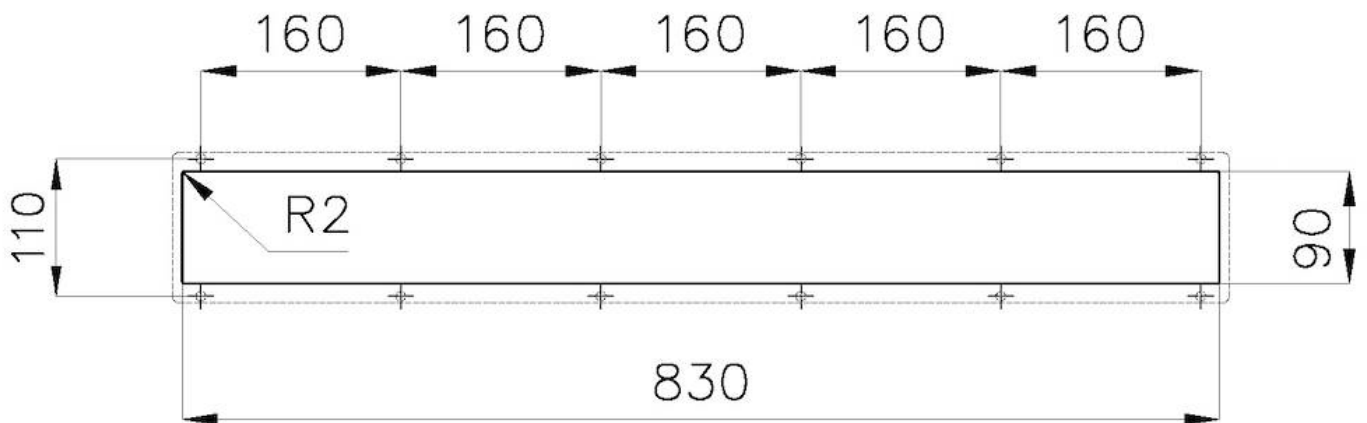

GALERIE



OPTIONALES ZUBEHÖR



Kit "I"
8100 707



Kit "L"
8100 708



Kit "M"
8100 709



Perforierte Edelstahlwanne
8151 004